



Operating Manual

AIO2-INS Series



Version: DM-AIO2-INS-EN 2.2-20220118

Contents

1	About This Manual	1
1.1	Products Covered by This Manual	1
1.2	Target Group.....	1
1.3	Symbols Used	1
1.4	Storage of the Manual.....	1
2	Safety.....	2
2.1	Intended Use	2
2.2	Important Safety Instructions.....	2
2.3	Storage and Transportation	3
3	Scope of Delivery	5
4	Product Description	7
4.1	View of the Inverter	7
4.2	Topology of the Inverter	9
4.3	System Diagram.....	9
4.4	Operating Mode Introduction	10
5	Mounting.....	13
5.1	Requirements for Mounting.....	13
5.2	Mounting the Inverter (with AIO2-BTLV-5KWH battery).....	15
5.3	Mounting the Inverter (with AIO2-BTLV-10KWH battery) ...	19
6	Electrical Connection.....	23
6.1	Wiring Diagram for Australia & New Zealand	23
6.2	Wiring Diagram for Europe	24
6.3	Overview of the Connection Area	25
6.4	PV Connection	26
6.5	Grid Connection	28
6.6	EPS Connection	31
6.7	Battery Connection.....	33
6.8	Smart Meter Connection.....	35
6.9	Wi-Fi Stick Connection	36
6.10	DRM Connection.....	37
7	Operating of the Inverter	38
7.1	Graphical Display.....	38

7.2	Commission	39
7.3	Decommission.....	40
7.4	Settings on the Soltaro APP	41
8	Troubleshooting and Maintenance.....	49
8.1	Troubleshooting	49
8.2	Maintenance	52
9	Technical Data.....	53
9.1	Specification of inverter.....	53
9.2	Specification of battery	55
9.3	Certificates and Grid Regulations	56
	Contacts:.....	58

1 About This Manual

1.1 Products Covered by This Manual





AIO2-INS Series Low Voltage Solar Hybrid Inverter:
AIO2-INS-3000, AIO2-INS-3680, AIO2-INS-4600, AIO2-INS-5000.

1.2 Target Group

This document is intended for qualified electrician. Any electrical installation and maintenance on this inverter must be performed by qualified electricians in compliance with standards, wiring rules or requirements of local grid authorities or bodies.

1.3 Symbols Used

The following types of safety precautions and general information symbols are used in this manual. These important instructions must be followed during installation, operation and maintenance of the inverter.

	Indicates a hazard with a high level of risk that will result in death or serious injury.
	Indicates a hazard with a medium level of risk that can result in death or serious injury.
	Indicates a hazard with a low level of risk that can result in minor or moderate injury.
	Indicates a situation which, if not avoided, can result in property damage.

1.4 Storage of the Manual

The manual should be stored with other documents belonging to the inverter and must be available to people authorized to work on

the installation.

This manual will be updated if necessary. Please check www.soltaro.com for more information.

2 Safety

2.1 Intended Use

The **AIO2-INS Series** are single phase solar hybrid inverters suitable for both on-grid and off-grid operation. With Lithium batteries, PV panels and a smart meter, the hybrid inverter is the central device to make a solar storage system for increased self-consumption.

The **AIO2-INS Series** must only be connected with a Soltaro lithium battery.

To prevent personal injury and property damage and to ensure long-term operation of the product, please read and follow all the instructions and cautions on the inverter and this user manual during installation, operation or maintenance at all times.

2.2 Important Safety Instructions



Danger to life from electric shock.

- Before performing any work on the inverter, disconnect all DC and AC power from inverter and wait for at least 5 minutes.
 - Do not touch DC conductors or any non-isolated cable ends.
 - If an error occurs, contact your local distributor or qualified electricians.
 - Make sure the inverter is not touchable from children.
-

⚠ WARNING**Risk of burns from hot surfaces.**

- The surface of the inverter might exceed 60°C, touching the surface may result in burns.
 - Do not touch hot surfaces before it cools down.
 - Only authorized service personnel are allowed to install the inverter or perform servicing and maintenance.
 - All powers, both AC and DC, should be disconnected from inverter before attempting any maintenance or cleaning or working on any circuits connected to inverter.
-

⚠ CAUTION

- The Inverter has a transformerless design on PV side. Either positive or negative terminals of PV panels should not be grounded.
 - The frames of PV panels should be grounded for safety reasons.
-

NOTICE











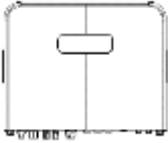



- Do not open inverter cover or change any components without authorization, otherwise the warranty commitment for the inverter will be invalid.
 - Appropriate methods must be adopted to protect inverter from electrostatic discharge, any damage caused by ESD is not warranted by the manufacturer.
-

2.3 Storage and Transportation

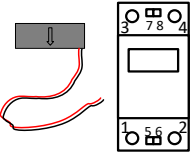
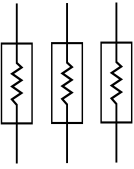
- Store the inverter in a dry environment where ambient temperature keep always between -20 °C - +60 °C. Take care of the inverter during the storage and transportation.
- The package shall not be tilted or inverted during transportation, handling and storage.

- When the inverter or other related components need to be disposed, make sure it is carried out according to local waste handling regulations.
- Please be sure to deliver waste inverters and packing materials to appropriate recycling centers where possible.

3 Scope of Delivery

 <p>A</p>	 <p>B</p>	 <p>C</p>	 <p>D</p>
 <p>E</p>	 <p>F</p>	 <p>G</p>	 <p>H</p>
 <p>I</p>	 <p>J</p>	 <p>K</p>	 <p>L</p>
 <p>M</p>	 <p>N</p>	 <p>O</p>	

Item	QTY	Designation
A	1	Inverter
B	1	Wall Mounting Bracket
C	2	Battery power cable (red cable is positive connection, black cable is negative connection)
D	1	BMS Cable
E	1	EPS Connector (Amphenol or Wieland)
F	1	Grid Connector (Phoenix or Wieland)
G	2	PV Connectors (Amphenol HC4 or Multi-Contact MC4) (2PV+, 2PV-)
H	1	Water-proof RJ45 Connector for DRM port
I	1	CT and Smart Meter
J	3	Terminal Resistor (1kOhm)
K	1	Smart Meter Communication Connector
L	8	Expansion Screws for Fixing Mounting Bracket
M	8	M5 Screws for Fixing Mounting Bracket & Inverter
N	1	User Manual
O	1	Wi-Fi Stick

4 Product Description

Thank you for choosing the SOLTARO AIO2 ESS product which is a single phase system. Inverters should not be used in multiple phase combinations. Features of the inverter are ahead of the field and should be understood prior to install.

4.1 View of the Inverter

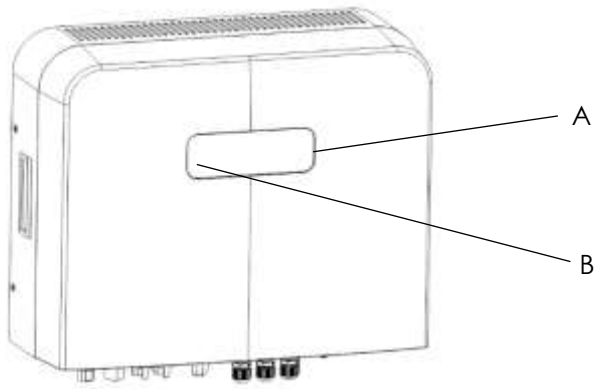











Figure 1. View of the AIO2-INS Series Hybrid Inverter

Position	Designation
A	Graphical Display
B	LED light. When inverter is running normally, the light is green. When error occurs, the light turns red.

Icons on the Nameplate

Symbol	Explanation
	CE Mark
	UKCA Mark
	Caution, Risk of Danger
	Caution, Risk of Electric Shock
	Caution, Hot Surface.
	Refer to the Operating Manual
	Danger, Risk of Electric Shock due to Stored Energy. Cut off all power and wait at least 5 minutes before any work is carried out on the inverter.
	G98 or G99 Mark for UK.
	RCM Mark for Australia and New Zealand.
	WEEE Mark. This inverter should not be disposed as ordinary waste.

4.2 Topology of the Inverter

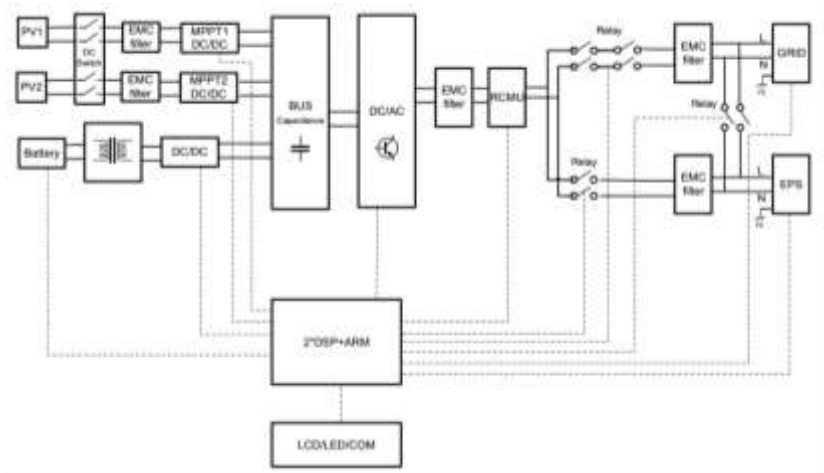
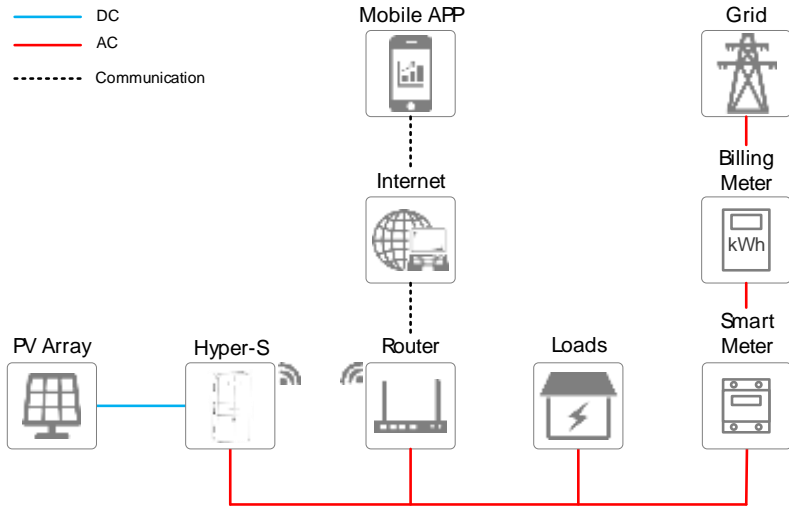

Figure 2. AIO2-INS Series Hybrid Inverter topology

4.3 System Diagram



4.4 Operating Mode Introduction

4.4.1 On Grid Self-Use Operating Mode

The on grid self-use operating mode is recommended for when the system is installed in an area with a stable grid. The purpose is to increase self-consumption of clean PV energy. When Inverter is set to work in this mode:

- i. During daytime and there is sufficient PV Power,**
 - The PV energy is used to supply local loads as first priority and then charge the battery, excess energy will be fed into grid*1*2.
 - When battery is fully charged, PV energy is supplied to the local loads and fed into grid*1*2.
- ii. During nighttime or there is not sufficient PV Power,**
 - Battery is discharged to supply local loads, if extra power is required, it will be imported from grid.
 - When the battery SOC is below the DischargeEndSOC@Grid value or fully discharged, the inverter will stop working and local loads will be supplied from the grid.
 - Thanks to the on-grid operation, the switch from battery power, PV power and grid power is automatic and seamless.
- iii. When grid fails,**
 - When grid fails, the inverter will automatically disconnect from grid and output power to the EPS port.
 - When battery is discharged to the DischargeEndSOC@EPS value, the inverter will stop working and wait for the grid to recover or until there is sufficient power from PV panels to charge the battery.
 - If grid failure can be a common occurrence in your area, you can adjust the DischargeEndSOC@Grid higher to ensure there is battery power available.
- iv. You can also:**

- Set a schedule for the inverter to charge the battery using cheap off-peak grid power.
- Specify the daily working periods of self-use for inverter.

*1: The inverter can be set not to feed power into the grid. But a small amount of energy will still inevitably be fed into grid due to unpredictable PV energy change and load fluctuations.

*2: Firmware update may be required to support this function.

NOTICE

For on-grid self-use operating mode, one can set the discharge end SOC@Grid as low as the battery allows (10% or 20% for example). Please refer to your local battery technician for minimum discharging end SOC.

4.4.2 Off Grid / Back-up Operating Mode*3

For systems installed in area with a weak grid or even without grid, the inverter should be working in off grid / back-up operating mode:

i. When grid or diesel generator is available,

- When the battery is below the DischargeEndSOC@Grid value, it will be charged firstly from PV and secondly from grid at the max allowable current.
- When the battery is above the DischargeEndSOC@Grid value, it will be charged by excess PV energy and will discharge if the PV power is not enough to support the loads.

ii. When grid or diesel generator is not available,

- When there is enough energy stored in the battery, the EPS port will export power to support local loads firstly from PV. If there's excess PV energy, it will be used to charge the battery. Otherwise battery will be discharged to feed the load.
- When the battery SOC is below the DischargeEnd SOC@EPS value, the inverter will disconnect power to the EPS port. All

energy from PV will be used to charge the battery until the SOC reaches the EPS restart value.

iii. When working in this mode:

- The max power*3 from the EPS port is limited by inverter type, battery type and battery SOC.
- A larger battery is always recommended for off grid / backup configuration. You should never discharge the battery too deeply to avoid it "Running Flat".
- When there is an overload or short circuit fault, the inverter will stop working and an alarm will sound. It will try to restart several times before shutting down completely. Turn off or unplug load to remove the short circuit fault or overload as soon as possible.

*2: Firmware update may be required to support this mode.

*3: Please be noted that refrigerators, air conditioners, water pumps and etc., demand a large start up currents and may trip EPS overload protection. Be sure not to connect too many of this kind of load to avoid frequent system shutdown and restart.

NOTICE

For off-grid / back-up operating mode, one should set a higher DischargeEndSOC@Grid value (above 50% for example). So that there will be some energy in battery when a grid failure occurs.

5 Mounting

5.1 Requirements for Mounting

NOTICE

Check to make sure the installation site does not fall into any of the following conditions: If it does, then a risk assessment will be required.



No direct sunlight



No rain exposure



No snow lay up

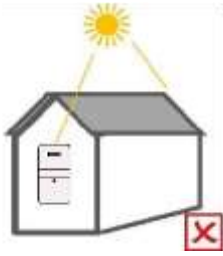

Direct sunlight



Rain exposure



Snow lay up

Clearance Recommendation

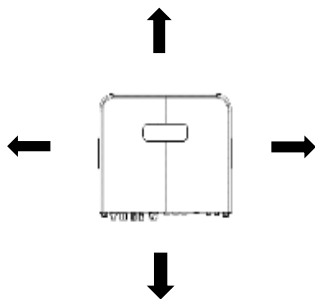

Position	Min.size
Left	600
Right	600
Top	600
Bottom	600
Front	300

Additional Notes:

- Unsafe due to assessment of occupational health safety risks.
- The ambient temperature is outside the range of tolerable ambient temperature (-20°C to +60°C, -4°F to +140°F).
- Higher than the altitude of 2,000m above sea level. Above 2000m the inverter output will be de-rated.
- Close to flammable materials or areas where flammable materials are stored.
- Prone to be damaged by seawater.
- Prone to be flooded or high levels of snowfalls.
- Close to corrosive gas or liquid (for example, locations where chemicals are processed or stored).
- Exposed to direct sunlight or in an enclosure exposed to direct sunlight.
- Little or no airflow
- Mounted on a surface without suitable fire/heat rating.
- Mounted on a wall without suitable load bearing capability.
- High humidity.
- Site is considered unsafe because of local regulations.
- Confined space without adequate airflow.
- Area subject to sand or dust storms.
- Exposed to steam, vapor, or water.
- Near antenna and/or data cables.
- Electrical Installation & Maintenance shall be conducted by licensed electrician and shall comply with Australia National Wiring Rules

5.2 Mounting the Inverter (with AIO2-BTLV-5KWH battery)

Procedure:

STEP 1:

Drill holes into the wall ($\varphi=12\text{mm}$, drilling depth $\geq 65\text{mm}$)

The dimensions of the back of the product are as follows (note: the height of the bottom row of holes $\geq 200\text{mm}$)

Unscrew the M8-60 expansion screw and put the expansion head into the drilled hole.

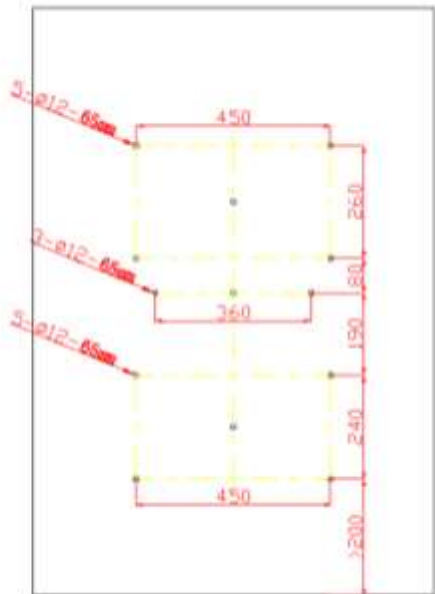

STEP 2:

Install the hanger with 5 M8-60 inner hexagonal expansion screws, as shown in the picture to the right.



STEP 3:

Hang the battery on the hanger. Note: Make sure that the four hooks of the hanger are all engaged, otherwise it will not be strong enough.

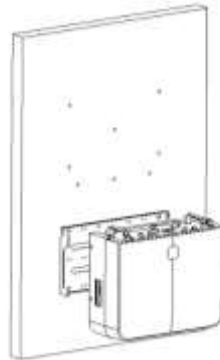

STEP 4:

Install the outer frame of the wiring area.
Place the frame of the wiring area on the battery, align the outer frame, and screw the three M5-10 stainless steel Phillips head screws into the three holes marked by the arrows.

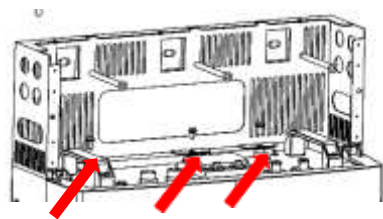

STEP 5:

The 3 M8-60 screws marked by the arrows fix the outer frame to the wall.



STEP 6:

Install the inverter hanger (use 3 M5-10 Phillips head screws to fix the inverter hanger to the frame of the wiring area. The inverter hanger is fixed to the wall with 5 M8-60 hex screws).

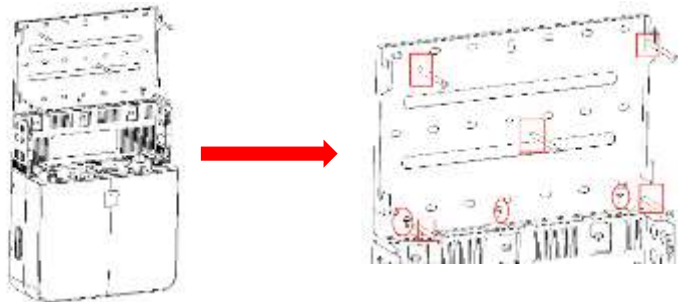

STEP 7:

Hang the inverter on the hanger (make sure the four hooks on the side of the rack are engaged, to prevent the inverter from falling).

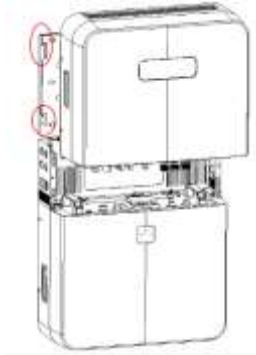

STEP 8:

After the battery and inverter are wired, buckle the cover of the wiring

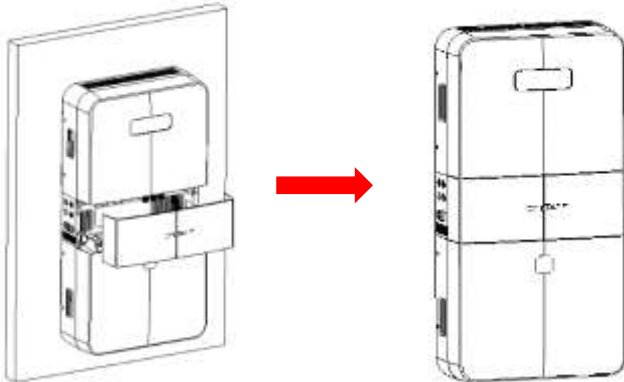

5.3 Mounting the Inverter (with AIO2-BTLV-10KWH battery)

Procedure:

STEP 1:

Drill holes in the wall ($\varphi=12\text{mm}$, drilling depth $\geq 65\text{mm}$)

The dimensions of the back of the product are as follows (note: the height of the bottom row of holes $\geq 200\text{mm}$)

Unscrew the M8-60 expansion screw and put the expansion head into the drilled hole.

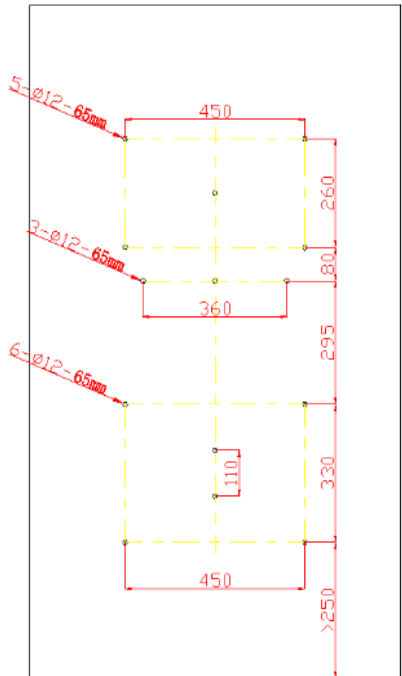
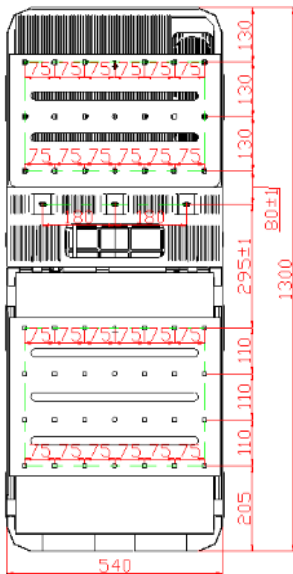

STEP 2:

Install the hanger with 6 M8-60 inner hexagonal expansion screws, as shown in the picture to the right.



STEP 3:

Hang the battery on the hanger. Note: Make sure that the six hooks of the hanger are all engaged, otherwise it will not be strong enough.



STEP 4:

Install the outer frame of the wiring area.

Place the frame of the wiring area on the battery, align the outer frame, and screw the three M5-10 stainless steel Phillips head screws into the three holes marked by the arrows.

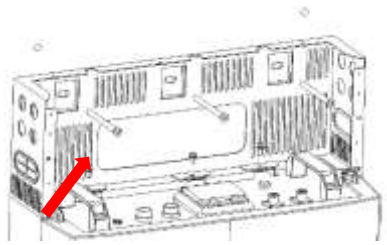

STEP 5:

Use 3 M8-60 screws to fix the frame on the wall, as shown in the picture to the right.

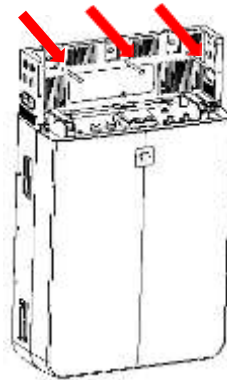

STEP 6:

Install the inverter hanger (use 3 M5-10 Phillips head screws to fix the inverter hanger to the frame of the wiring area. The inverter hanger is fixed to the wall with 5 M8-60 hex screws).

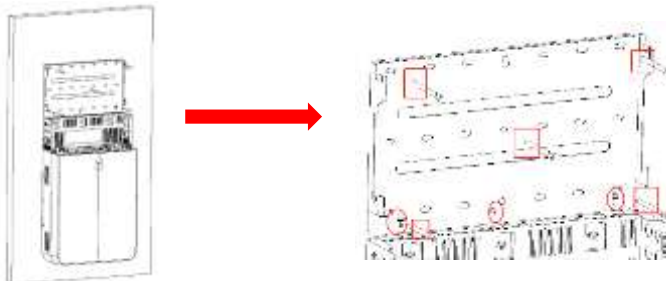

STEP 7:

Hang the inverter on the hanger (make sure the four hooks on the side of the rack have been engaged to prevent the inverter from falling).

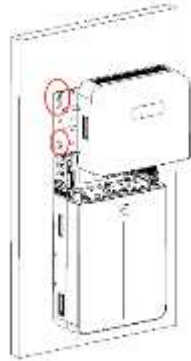

STEP 8:

After the battery and inverter are wired buckle the upper cover of the wiring ar



6 Electrical Connection

6.1 Wiring Diagram for Australia & New Zealand

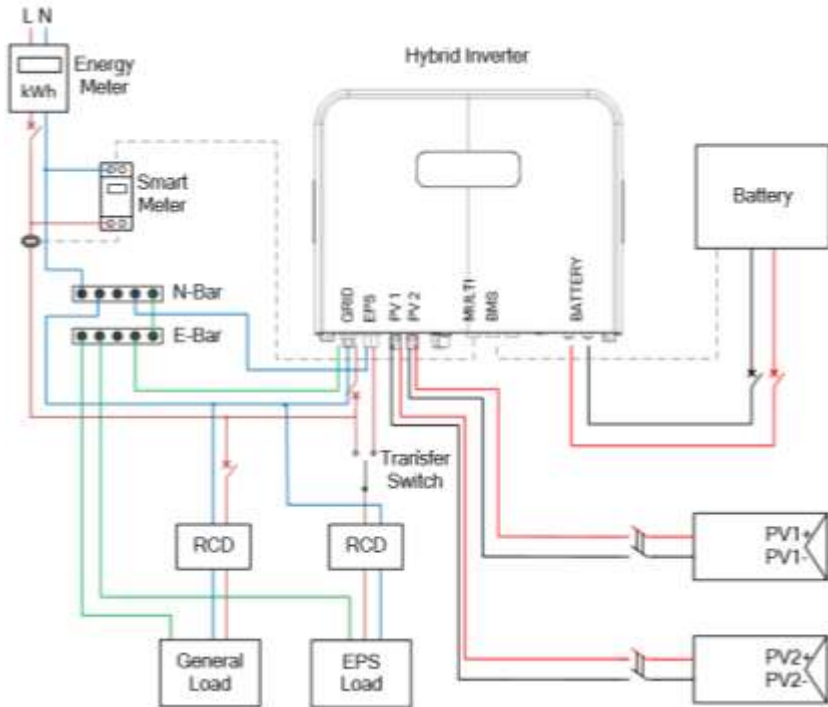

⚠ WARNING

In Australia and New Zealand, electrical installation and maintenance shall be conducted by a licensed electrician and shall comply with Australia/New Zealand National Wiring Rules. Because the inverter does not maintain neutral integrity during grid failure, an external neutral connection must be used in Australia and New Zealand. 30mA Type "A" RCD can be used.

6.2 Wiring Diagram for Europe

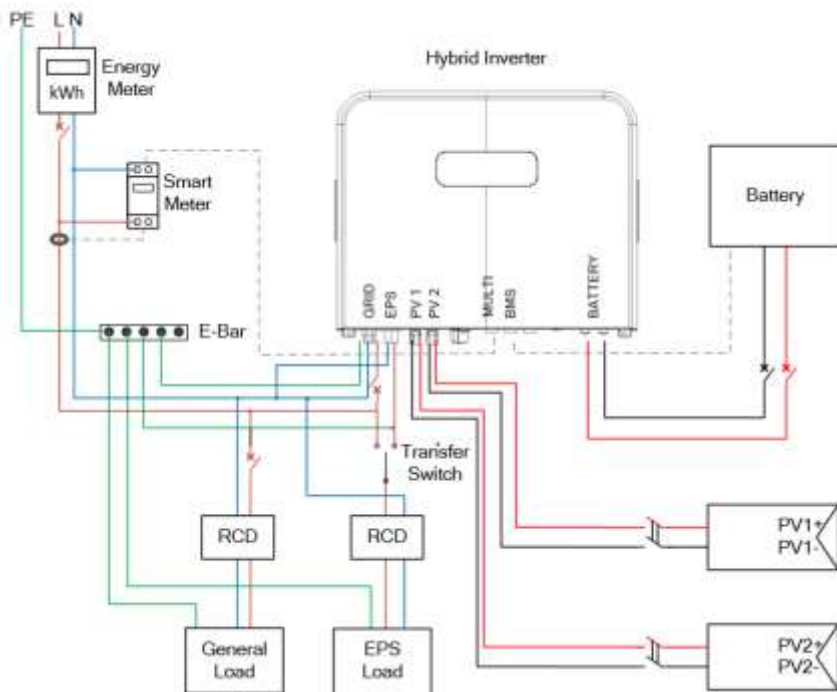

6.3 Overview of the Connection Area

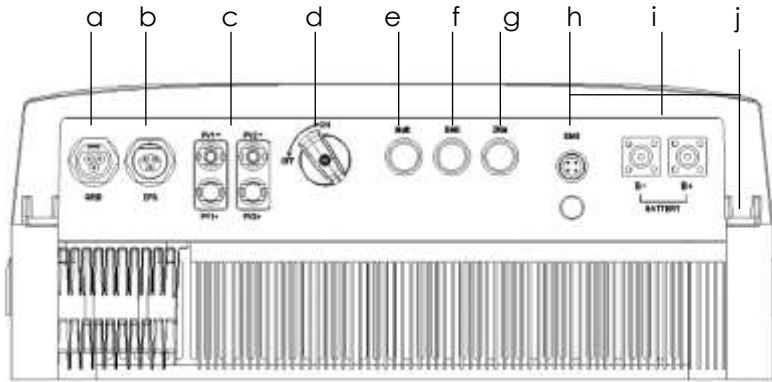

Position	Designation
a	Grid Connector
b	EPS Output
c	PV Inputs
d	DC Switch (optional, not for Australia)
e	MULTI Port (for Meter & Other Communications)
f	BMS Port
g	DRM Port
h	EMS Port (for Wi-Fi Stick or other EMS Controllers)
i	Battery Connectors
j	Additional Grounding Point

6.4 PV Connection

Please only use the PV connectors from the accessory box for connection.

Before connecting, please make sure:

- The voltage, current and power ratings of the panels to be connected are within the allowable range of the inverter. Ensure polarity is correct. Please refer to the Technical Data in chapter 9 for voltage and current limits.
- Since the inverter is transformerless, please do not ground either output of the PV panels. Ground the panel frames.
- The 3.68kW/4.6KW/5kW inverter is designed with 2 MPPT trackers, if the inputs of the PV panels are paralleled, please consult with your local distributor for technical support.
- If the inverter is equipped with a PV switch, please make sure it is in the “off” position. Otherwise please use an external PV switch to switch off the PV connection during wiring and when necessary for maintenance.

Procedure:



- Use IEC61730 class-A Rating PV modules.
 - When exposed to light, PV panels will generate DC voltage.
 - Turn off the PV switch before connecting any wiring.
-

STEP 1:

- Assemble the PV connectors from the accessory box.
- Make sure the polarity is correct.
- Ensure you are using correct tools for crimping connections.

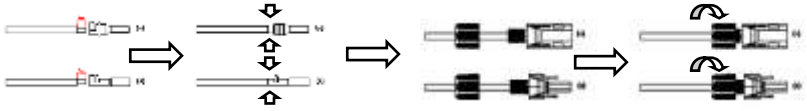
**NOTICE**

DO NOT crimp the two metal sheets (below picture).

These are fixing structure of metal core and its plastic shell. Crimping of the two metal sheets will result in failure of assemble, which may cause contact problems, and even fire in extreme cases.

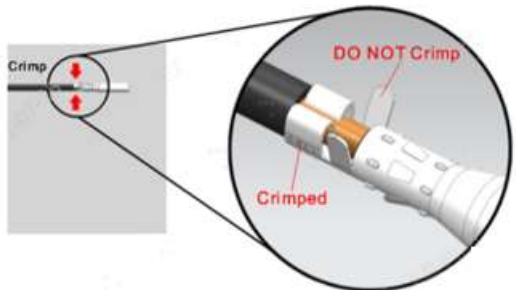

STEP 2:

- Connect the PV connectors to the inverter. There should be a “click” to indicate firm connection.

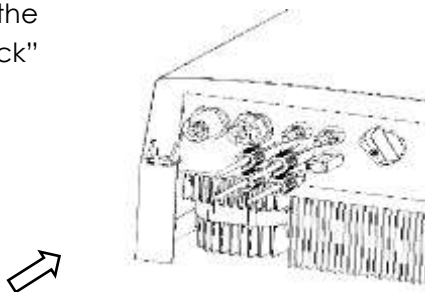

6.5 Grid Connection

Please use the Grid connector from the accessory box for connection. Before connecting, please make sure:

- The grid voltage and frequency must be in the permissible range.
- An external AC switch ($\geq 32A$) must be used on the Grid connection to cut the inverter off from the Grid when necessary.

Procedure:

STEP 1:

- Assemble the Grid connector.
- Make sure Live/Neutral/PE

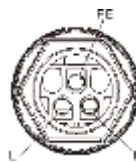

wire are correct, please follow the markings on the connector.



STEP 2:

Connect the Grid plug to the inverter.

A “click” sound will indicate firm connection.

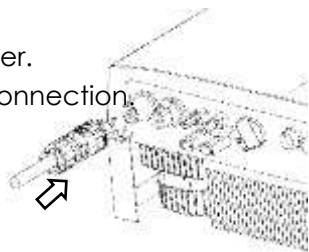

WARNING

High leakage current!

- Earth connection essential before connecting supply.
- The inverter has a ground fault detection function, once an earth fault occurs, the fault code "F2:00000001" will be displayed on the LCD screen. The inverter will also beep repeatedly until the fault is rectified.

NOTICE

- For some special AC connector, when pull out the wire connector, a hook structure of device connector (as pic. 1) may be pulled out, together with the wire connector (as pic. 3) or separately (as pic. 4).
- One needs to put the hook back to the device connector.
- It is normal for this type of connector, which will not affect the use. This design can prevent possible cracks of the hook

structure.

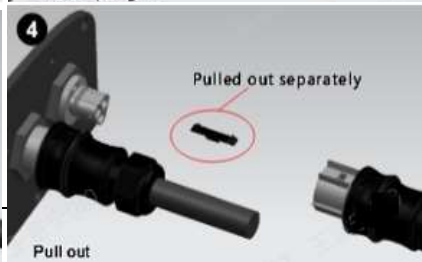
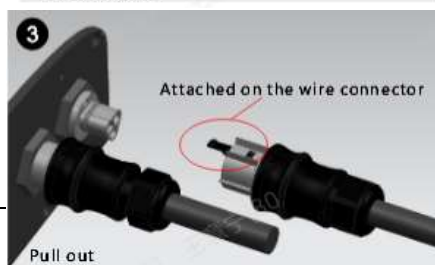
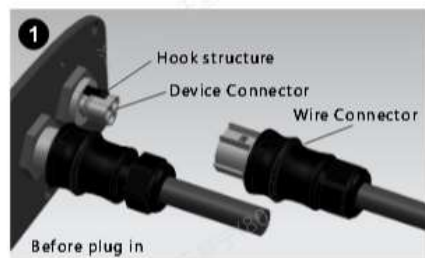

6.6 EPS Connection

If you want to use the energy storage system to power the house (as a standalone system or during Grid failure), the EPS connector should be used and the EPS function should be enabled during setup. Otherwise you can leave the EPS port disconnected. Where possible, an external switch to bypass the inverter to power backup loads directly from the grid must be installed.

Before connecting, please check the following:

- The grid voltage and frequency must be in the permissible range.
- External AC switches must be used on EPS connection to cut off the inverter from EPS load when necessary.
- External switch must not allow connection of EPS circuit to Grid. A 3 position switch with intermediate OFF position and a minimum current rating of 32A is recommended.

Procedure:

STEP 1:

- Assemble the EPS connector.
- Make sure Live/Neutral/PE wires are correct; please follow the markings on the connector

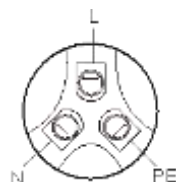

STEP 2:

- Connect the EPS plug to the inverter. A “click” sound will indicate firm connection.

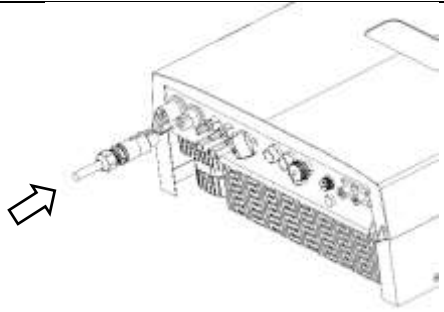

Declaration for backup loads :

Soltaro AIO2-INS inverter is able to supply a continuous 5000VA output (max 5500VA for 10s) on EPS side. Inverter will shut down under full loading with high ambient temperature if grid is absent. Extra battery may be required to achieve full inverter surge capacity.

Accepted loads as below:

- Inductive Load: Max 1.5KVA for single inductive load, max 2.5KVA for total inductive load power
- Capacitive load: Total capacitive load (like computer, switch power etc.) power $\leq 3.0\text{KVA}$

(Any load with high inrush current at start-up is not supported on EPS circuit).

NOTICE

- Soltaro AIO-INS series inverter is intended to be used as a backup supply for residential loads only.
 - Any commercial or industrial usage of the backup supply should be checked with Soltaro Support, as there may be extra requirements or limitations.
-

6.7 Battery Connection

6.7.1 Battery connection diagram

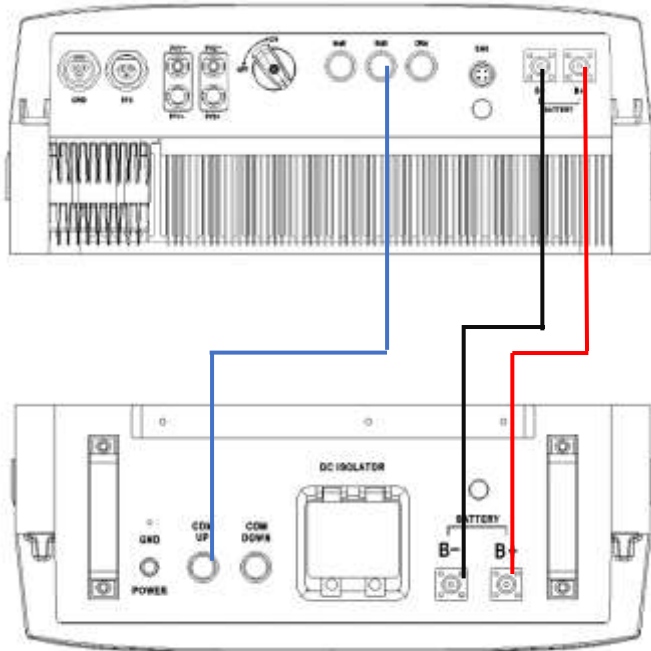

6.7.2 Battery Power Connection

Procedure:

STEP 1:

- Please use the pre-assembled battery power wire in the accessory box for connection.

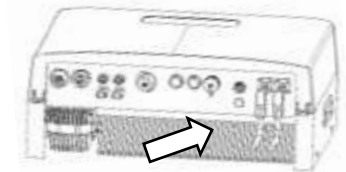

STEP 2:

- Connect the battery cables to the inverter. A “click” sound will indicate firm connection.
-

⚠ CAUTION

- A DC breaker with OCP capability must be installed between inverter and battery. The battery may have this switch integrated. If not, an external DC switch of proper ratings should be used.
 - Please note that the waterproof cover of the IP65 battery circuit breaker should be closed and locked in time after installation.
-

6.7.3 BMS Communication Connection

Please check whether the BMS communication cable in the accessory box is appropriate for the battery. If you are not sure, please confirm with your battery vendor.

Procedure:**STEP 1:**

- Please insert the connector with water-proof cap into the port marked with "BMS" on inverter and fasten the cap.

**STEP 2:**

- Please insert the other end of the cable in the corresponding port in battery.

BMS Conn**ion:**

1. BMS_CAN_H
2. BMS_CAN_L
3. BMS_485_A
4. NULL
5. BMS_485_B
6. NULL

6.8 Smart Meter Connection

Procedure:

STEP 1: Normally the smart meter should be placed in or near the grid distribution box right after the billing meter.

STEP 2: Assemble the smart meter connector. Make sure the wires are correct; please follow the markings on the connector.

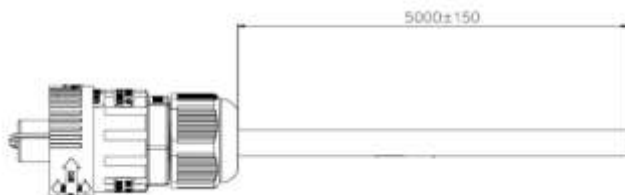

CAUTION

Smart Meter CT MUST be wired into the smart meter BEFORE clamping around a live cable.

STEP 3: Please use the smart meter connector in the accessory box for communication. Insert the connector with water-proof cap into the port marked "MULTI" on inverter and fasten the cap.

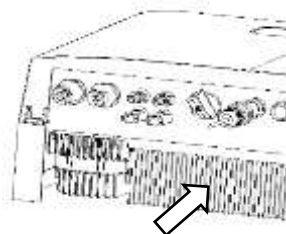

STEP 4: The wires on the other end should be stripped and connected to the smart meter accordingly. If the supplied cable must be replaced to be longer, please install the included 1kohm resistor.

“MULTI” Connector Pin Definition



- + : RS485B (orange)
- : RS485A (orange white)

Smart meter type: CHINT DDSU666-D

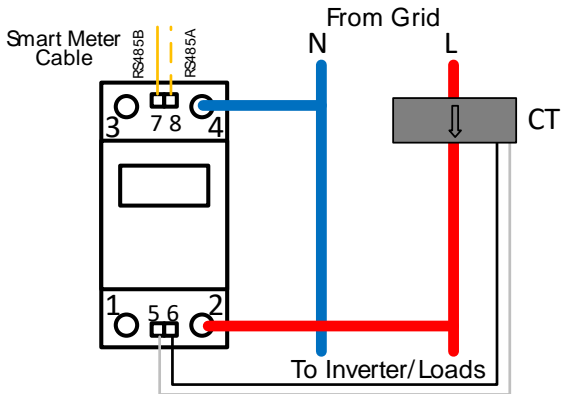

6.9 Wi-Fi Stick Connection

Procedure:

STEP 1:

- Insert the Wi-Fi stick to the EMS port and fasten the nut tight.

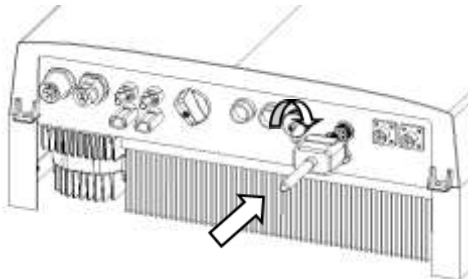

“EMS” Connector Pin Definition

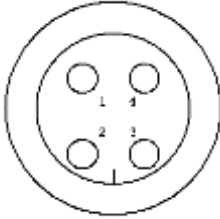

1. +5V
2. GNDD
3. RS485A
4. RS485B

6.10 DRM Connection

DRM is provided to support several demand response modes by certain control signals.

“DRM” Connector Pin Definition

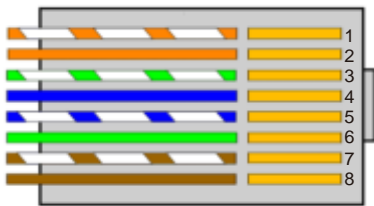

1. DRM1/5
2. DRM2/6
3. DRM3/7
4. DRM4/8
5. 3.3V
6. DRM0
7. 3.3V
8. GND

7 Operating of the Inverter

7.1 Graphical Display

The graphical display shows the detailed information of the inverter.

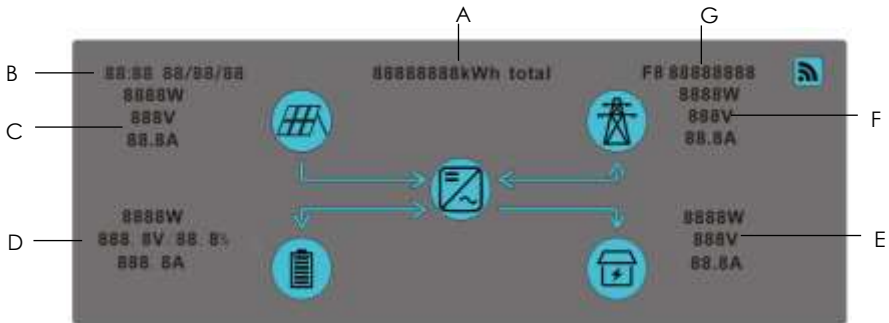

Position	Designation
A	Total energy the inverter has produced.
B	Time and date
C	PV system real-time parameters, including power, voltage and current. If the connection to PV is disconnected, the icon, arrow and data will not be displayed on the screen.
D	Battery real-time parameters, including power, voltage/SOC and current. If the connection to battery is disconnected, the icon, arrow and data will not be displayed on the screen.
E	Load consumption real-time parameters, including power, voltage and current. If the connection to load is disconnected, the icon, arrow and data will not be displayed on the screen.

F	Grid parameters, power, voltage and current. If the connection to grid is disconnected, the icon, arrow and data will not be displayed on the screen.
G	Error Code. It will be displayed when an error occurs.

7.2 Commission

Before commissioning the inverter, make sure:

- The country mark on the box is in accordance with the installation site;
- The inverter is correctly and firmly mounted;
- The Circuit breaker and RCD are correctly connected and are all in "off" position;
- All cables are connected according to chapter 6;
- Unused inputs must be sealed using the corresponding connectors or sealing plugs.

Procedure:

STEP 1: Power on the Grid

- Wait for a while, the green LED should be glowing and the graphical display should start displaying. The icon of grid and its parameters should appear on the screen. If not, please power off and check for the connections of grid power line and smart meter.

STEP 2: Power on the Battery

- The battery icon and its parameters should be shown on the screen.

STEP 3: Power on the PV

- If there's sunlight, the PV icon and its parameters should be shown on the screen.
 - Wait for a moment and the inverter will start a self-test procedure. When it is done successfully, the inverter will start using PV power to charge the battery or feed in power to the
-

house and grid.

STEP 4: Switch on the loads

- The load parameters should show.
-

STEP 5: Configure the Wi-Fi stick

- Configure the Wi-Fi stick for remote monitoring. Please follow the instructions manual in the Wi-Fi stick's packing box. Otherwise, please contact Soltaro and we will provide detailed instructions.
-

STEP 6: Self-test in accordance with CEI 0-21 (Italy Only)

- The self-test is only required for inverters to be commissioned in Italy. During the self-test, the inverter will consecutively check the reaction times for: overvoltage, undervoltage, maximum frequency and minimum frequency.
 - Please use the Soltaro APP to initiate the self-test procedure and get the test results. Refer to Soltaro APP Operation Instructions for details.
-

7.3 Decommission

STEP 1: Turn off the load;

STEP 2: Turn off the PV;

STEP 3: Turn off battery;

STEP 4: Turn off the main grid switch;

STEP 5: Wait for at least 5 minutes after the LED and graphical display black out for the internal circuits to discharge energy;

STEP 6: Disconnect all the power cable;

STEP 7: Disconnect all the communication cable, Remove the Wi-Fi stick;

STEP 8: Remove the inverter from the wall, also remove the bracket if necessary;

STEP 9: Pack the inverter with the original carton, and store it.

7.4 Settings on the Soltaro APP

7.4.1 User Interface Introduction

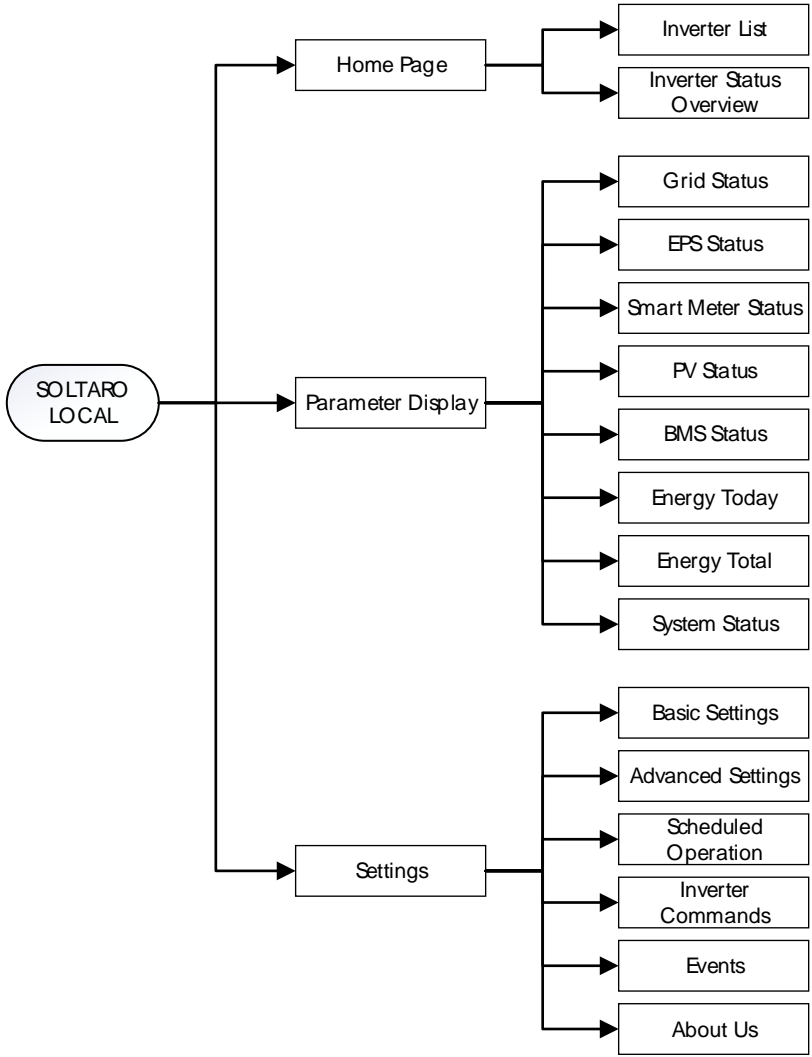

7.4.2 Install the APP and Connect to the Inverter

Procedure:

STEP 1: Install Soltaro APP

- Download the app on iOS APP Store and/or Google Play, and install it on the mobile phone or tablet.
-

STEP 2: Connect to the inverter

- Connect the mobile phone or pad to the same wireless network (Wi-Fi) as the inverter;
 - Open the APP, click the arrow on the upper right corner of home page;
 - Search the inverter ID, and connect to target inverter;
 - If it is successfully connected, the home page will show the general status of the inverter. You can also check the detailed status in the Parameter interface.
-

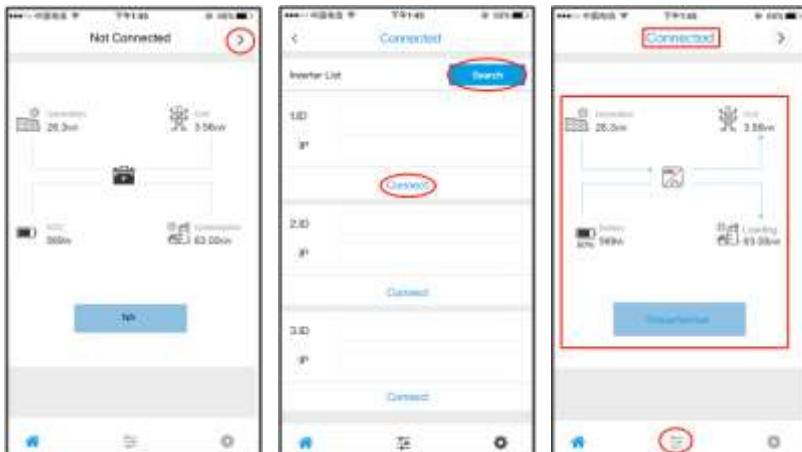

7.4.3 Check the Country

The country setting is protected with a password. Each country code represents corresponding local protective parameters that have been preset before delivery.

Procedure:

STEP 1: Enter the Setting interface

- Enter the Settings interface, click “Basic Settings”;
- Write in the password to enter the submenu. This can be accessed by contacting Soltaro.

STEP 2: Set the country

- Check the “Country”, make sure it is your current location;
- If it is not your current location, please choose the right country, and click “Apply” to save the setting.

NOTICE

The inverter complies with AS/NZS 4777.2:2020, people in Australia need to select the corresponding Australia Region A/B/C for grid protection settings and power quality response modes settings. Please contact your local grid operator for which region to select.

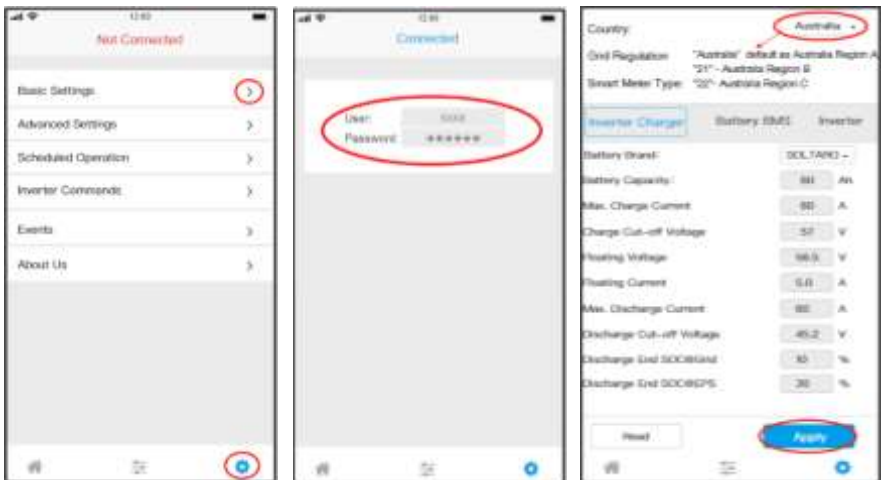

7.4.4 Export Power Limit

You can set Grid Feed Power Limitation value (W) to enable Export Power Limit when your local grid operator allows limited external power feed into grid.

NOTICE

- Only effective when smart meter connected in the system.
- If you use this function and set a Power limit value, then PV production could be limited if consumer load or battery charge power is low.

Procedure:

Step 1: Enter the Setting interface

- Go to Settings interface, click “Basic Settings”.

Step 2: Set Grid Feed Power Limitation

- Click “Inverter”;
- Set Value of the Grid Feed Power/Inverter Power to allowable grid export/inverter output, according to your situation and/or local regulations;
- ✓ Inv. Power Limitation (W): the allowable output power of the hybrid inverter (Default: Inverter nameplate power)
- ✓ Grid Feed Power Limitation (W): Default value “65535” means Export Power Limit OFF, no limit on export to grid.
- Click “Apply”, to save the settings.

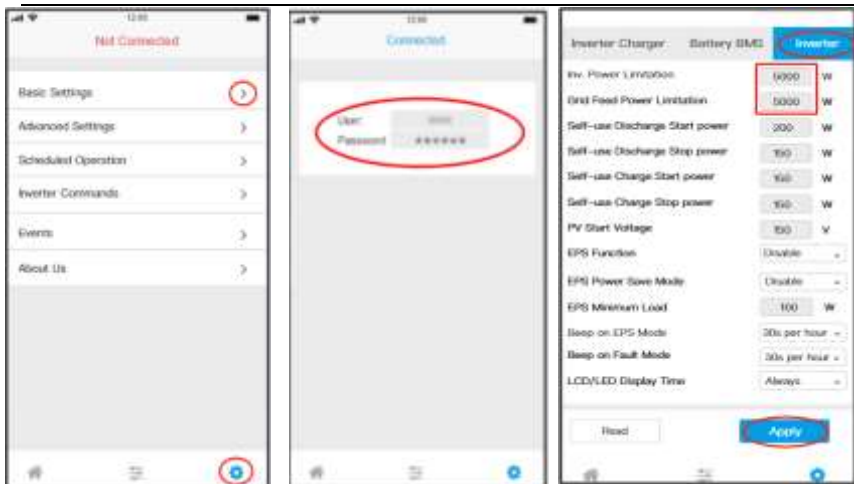

7.4.5 Check Firmware & Time Synchronization

You can check the Inverter's SN, Firmware version and do Time Synchronization on the same page. It is recommended to perform Time Synchronization first after the inverter is installed and successfully connected to the Soltaro Local APP and then to set or modify the parameters.

Procedure:

STEP 1: Enter the Setting interface

- Go to the Settings interface, click "Inverter Commands".
-

STEP 2: Check Firmware

- You can check the Serials (SN), Hardware code or firmware on this page.
-

STEP 3: Time Synchronization

- Click "Time & Date Sync." to calibration and synchronize time.
-

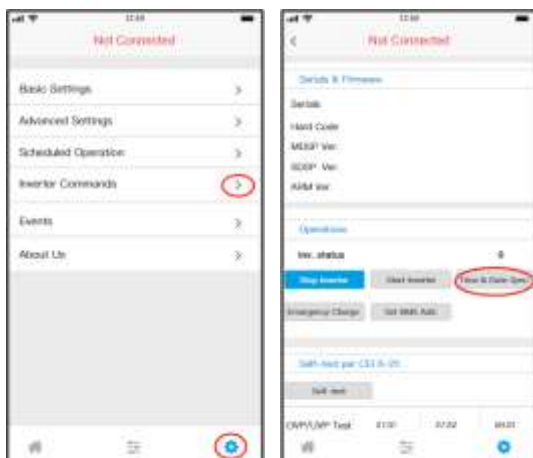

7.4.6 Scheduled Operation (optional)

Procedure:

STEP 1: Enter the Setting interface

- Go to Settings interface, click "Scheduled Operation".

STEP 2: Set the Operation Periods and Parameter

- Enable the Scheduled Operation;
- Set the operation period and parameters, according to your requirements;
- You can also set the discharge period for the EPS mode, if necessary.
- Click "Apply" to save the setting.

NOTICE

If the scheduled periods conflict, the priority of period 1 is higher than period 2, which is higher than period 3, and so on.

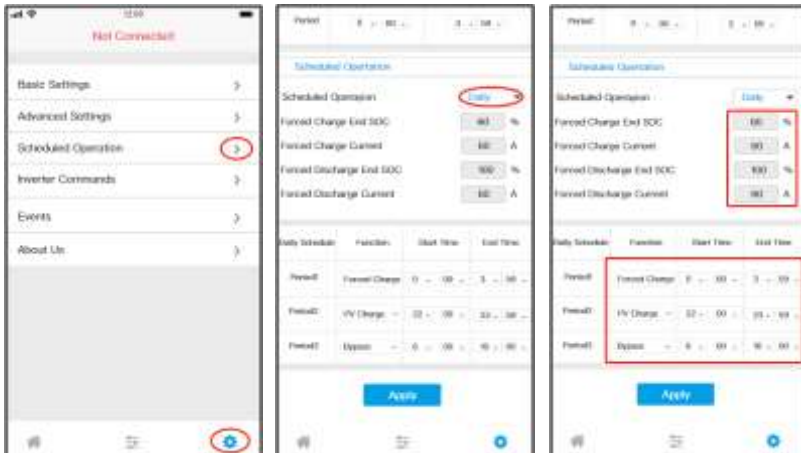

7.4.7 Power Quality Response

The AIO2-INS Series Hybrid Inverter supports power quality response modes which can be enabled/disabled and setup/adjust via the Soltaro Local APP.

Procedure:

STEP 1: Enter the Setting interface

- Go to Settings interface, click "Advanced Settings".
-

STEP 2: Volt-Watt response

- Click "Volt-Watt response". The three "function control" correspond to the Volt-Watt mode, Volt-Watt mode for charging, Volt-Var mode.
-

STEP 3: Power derating for voltage variation (Volt-Watt mode)

- The inverter power output will vary in response to the AC grid voltage. This is switched on by default.

It can be enabled/disabled by the button on the right of "function control" and adjusted through the parameters underneath if needed.

STEP 4: Reactive power regulation for voltage variation (Volt-Var mode)

- The inverter power output will vary in response to the AC grid voltage. The function is switched off by default.

It can be enabled/disabled by the button on the right of "function control" and adjusted through the parameters underneath if needed.

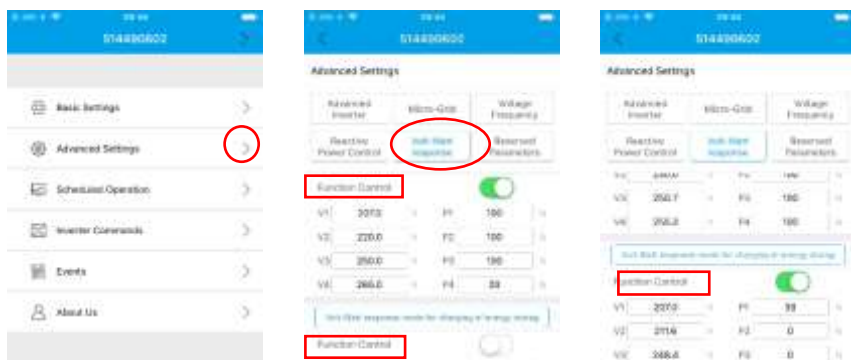

8 Troubleshooting and Maintenance

8.1 Troubleshooting

This chapter is a guide for troubleshooting problems that may arise in the installation and operation of AIO2-INS Series inverters.

In the event that more than one error is generated at the same time, the hexadecimal error corresponding to each alarm is added together. That is to say, if error code 0006H is displayed, errors 0002H and 0004H are being produced simultaneously.

Error Code	Description	Solution
F1:00000001	PV1 OVP	Check the configuration of connected PV Panels.
F1:00000002	PV1 OCPs	
F1:00000004	PV2 OVP	
F1:00000008	PV2 OCPs	
F1:00000010	System generation insufficient	
F1:00000020	M_PV OCPH	
F1:00000040	M_Bus OCPH	
F1:00000080	M_BAT OCPH	
F1:00000100	Grid Voltage Abnormal	Check if grid fails.
F1:00000200	Grid Frequency Abnormal	
F1:00000400	M_DC Bus OVP	These errors will reset itself. If it keeps coming and finally the Inverter is latched up, please contact with your local distributor.
F1:00000800	AC OCPs	
F1:00001000	DC Component of AC Current Abnormal	
F1:00002000	Leakage Current Protection	
F1:00004000	M_AC OCPH	
F1:00010000	EPS Voltage Abnormal	Check the EPS load. Unplug some to see if too much loads are
F1:00020000	EPS OCP	
F1:00040000	EPS over load	

F1:00080000	EPS SCP	connected.
-------------	---------	------------

Error Code	Description	Solution
F1:00100000	Over Heat P1	Wait for the Inverter cools down. Check if the installation place is too hot. These errors will reset itself. If it keeps coming and finally the Inverter is latched up, please contact with your local distributor.
F1:00200000	Over Heat P2	
F1:00400000	Over Heat P3	
F1:00800000	Bat. OTP	
F1:01000000	Bat. Voltage Protection	
F1:02000000	Bat. OCP	
F1:04000000	S_AC OCPH	
F1:08000000	S_BAT OCPH	
F1:10000000	M_Bus OCPH	
F1:20000000	Mid BUS OVP1	
F1:40000000	S_PV OCPH	
F1:80000000	S_DC BUS OVP	
F2:00000001	Grid Grounding Fault	
F2:00000002	L/N Reversely Connected	Check the L/N wire.
F2:00000004	Insulation Fault	Check the insulation of PV panels.
F2:00000008	RCMU Fault	Check the PV Panels.
F2:00000010	Grid Relay Fault	These errors will reset itself. If it keeps coming and finally the Inverter is latched up, please contact with your local distributor.
F2:00000020	EPS Relay Fault	
F2:00000040	Bypass Relay Fault	
F2:00000080	EEPROM1 Error	
F2:00000100	Single Faults	
F2:00000200	Internal Comm. U1~U2	
F2:00000400	Internal Comm. U1~U3	
F2:00000800	Internal Comm. U2~U3	
F2:00001000	PV1 reverse	
F2:00002000	PV2 reverse	
F2:00004000	Firmware not compatible with U1 and U2	

Error Code	Description	Solution
F3:00000001	BMS External Fault	Check the battery for

F3:00000002	BMS Internal Fault	parameter settings. Contact with your local battery's distributor.
F3:00000004	BMS OVP	
F3:00000008	BMS UVP	
F3:00000010	BMS Charge OCP	Check the battery for parameter settings. Contact with your local battery's distributor.
F3:00000020	BMS Discharge OCP	
F3:00000040	BMS OTP	
F3:00000080	BMS UTP	
F3:00000100	Cell Imbalance	
F3:00000200	Cell UVP Alarm	
F3:00000400	External Comm. Smart Meter	These errors will reset itself. If it keeps coming and finally the Inverter is latched up, please contact with your local distributor.
F3:00000800	Internal Comm. ARM and DSP	
F3:00001000	System crash alarm	
F3:00002000	EPS off alarm	
F3:00004000	External Comm. BMS	Communication between Inverter and BMS is not working. Check BMS cabling is connected correctly and battery powered on. Check BMS setting for inverter.
F3:00008000	DSP no firmware	

8.2 Recommended Maintenance

To ensure that the inverter can operate properly for a long term, you are advised to perform routine maintenance on it as described in this chapter.

⚠ CAUTION

Risk of inverter damage or personal injury due to incorrect service!

Always keep in mind that the inverter is powered by dual sources: PV strings and utility grid.

Before cleaning the system, connecting cables, and maintaining the grounding reliability, power off the system (see 7.3 Decommission the System for details)

Maintenance list

Check Item	Method	Period
System clean	Check the temperature and dust of the inverter. Clean the inverter enclosure if necessary.	Once every 6 to 12 months
System running status	Check whether the inverter is not damaged or deformed or can be operated with no abnormal sound.	
Cable entry	Check whether the cable entry is insufficiently sealed, or the gap is excessively large, and reseal the entry when necessary.	
Electrical connection	Check whether all cables are firmly in place. Check whether a cable is damaged, especially the part contacting the metal enclosure.	

9 Technical Data

9.1 Specification of inverter

Inverter Model	AIO2-INS- 3000	AIO2-INS- 3680	AIO2-INS- 4600 AIO2-INS- 5000
AC Output @ Grid			
AC Input Voltage / Frequency	186 ~ 264Vac/ 50 or 60Hz		
Nominal AC Power	3000W	3680W	4600W/5000W
Nominal AC Current	13.0A	16.0A	20A/21.7A
Current (inrush)	35A/10ms	35A/10ms	35A/10ms
Maximum output fault current	80A/3ms	80A/3ms	80A/3ms
Conditional short-circuit current (I _{cc})	80A/3ms	80A/3ms	80A/3ms
Maximum output overcurrent protection	19.5A	24A	30A/33A
Recommended circuit breaker	20A type C/D	25A type C/D	32A type C/D
THD of AC Current	<3%		
AC Output @ Off Grid			
AC Output Voltage / Frequency	220Vac / 50 or 60Hz, Single Phase		
Continuous Output Power (@25C)	3kVA	3.68kVA	4.6kVA/5kVA
AC Output Current	13.0A	16.0A	20A/21.7A

Peak Power	1.1 x P _{nom} , 10 sec; 1.5 x P _{nom} , 100 ms		
Power Factor	0.8 inductive to 0.8 capacitive		
Waveform	Pure Sinusoidal Wave		
THD of AC Voltage	<3% with Resistive Load		
Solar Input			
Max. allowable PV panel power	4500W	5500W	7500W
Max. input power	3300W	4000W	5400W
Open circuit voltage	600V		
MPPT voltage range	125-500 V		
Max. PV current	12A	12/12A	12/12A
Max. Short Circuit Current	15A	15/15A	15/15A
Strings per MPP Tracker	2	1	1
Number of MPP Trackers	1	2	2
Max. inverter backfeed current to the array	0 A	0 A	0 A
Galvanic Isolation for PV Modules	Transformerless		
Battery Input			
Battery Type	Lithium Battery		
Battery Voltage	40~60V		
Galvanic Isolation for Battery	YES		
Max Charge Current	60A	80A	100A
BMS Communication	CAN/RS485		
Protection	Over Voltage, Under Voltage, Over Current, Short Circuit,		

	Over Temperature		
Efficiency			
MPPT Efficiency	99.90%		
Euro Efficiency	96.50%		
Max. Efficiency	97.80%		
Battery Charge Efficiency	95%		
General Data			
PV inverter topology	Non-isolated		
Dimensions	540*430*210 mm (inverter)		
Weight	27kg	29kg	34kg
Mounting Information	Wall mount		
Operating Temperature	-10°C to +60°C (up 45°C derating)		
Relative Humidity	0 to 100%RH		
Site Altitude	Up to 2000m above sea level without derating		
IP Protection Type	IP65		
Protective class	Class I		
Cooling Concept	Free convection		

9.2 Specification of battery

Battery Model	AIO2-BTLV-5KWH	AIO2-BTLV-10KWH
Electrical Data		
Cell Type	LFP	
Total Energy	5 kWh	10kWh
Max. Depth of Discharge	90%	
Nominal Voltage	51.2 V	
Operating Voltage	40-58.4 V	

Range		
Nominal Capacity	100 Ah	200Ah
Max. Charge Current	50 A	100 A
Max. Discharge Current	100 A	100 A
Max. Parallel Number	3 units	
General Data		
Mounting information	Wall mount / Ground mount	
Communication	CAN / RS485	
Operating Temperature	0~45°C charge / -10~50°C discharge	
Dimension	540*430*210 mm	540*680*210 mm
Weight	45 kg	85 kg
IP Protection Type	IP65	

9.3 Certificates and Grid Regulations

•**EMC:**

EN61000-6-1, EN61000-6-2, EN61000-6-3, EN61000-6-4,
EN61000-4-18, EN61000-4-29

•**Safety:**

IEC/EN62109-1 & -2,
IEC62477-1

•**Grid Regulations:**

G98, G99;
AS/NZS4777.2;
C10/11;
EN50549

Contacts:

Head Office & Showroom

8 Mohr Street, Tullamarine, VIC, Australia 3043

Tel:+61 1300 276 582

Email: service@soltaro.com Support Head Office

service.au@soltaro.com Australian Support

UK/Europe Office

Unit 8, High Grounds Industrial Est., Worksop, Notts, S80 3AF, United Kingdom

Tel:+44 (0)1909 807 577

Email: service.uk@soltaro.com

South Africa Office

Office 642 Amelia Road, Lanseria Corporate Park, Lanseria South Africa 1739

Tel:+27 (0)11 318 6583

Email: service.sa@soltaro.com

Website

WWW.SOLTARO.COM

Registration URL

<https://soltaro.com/product-registration>